



Payment Services

User guide

xenta PINPAD



Table of contents

1	Security requirements	3
1.1	Electromagnetic compatibility	3
1.2	Where wireless technologies are used	3
1.3	CE declaration of conformity	4
2	Product info	5
2.1	Terminal overview	5
2.2	Display symbols	6
2.3	Abbreviations/Information	8
2.4	Payment procedure with ep2	9
2.5	Technical information	10
3	Commissioning	11
3.1	Installation	11
3.2	Configuration/Initialization	12
4.	Transactions	13
4.1	Card without PIN	13
4.2	Card with PIN	14
5	Menu tree (illustration)	15
5.1	Main menu	15
6	Balances	16
6.1	Start user shift/end user shift, daily closing, data transmission	16
7	Queries, settings	17
8	Setup	18
9	Maintenance and handling	19
9.1	Care and maintenance	19
9.2	Identifying and solving errors	20

1 Security requirements

1.1 Electromagnetic compatibility

When connecting additional or other components the “Electromagnetic Compatibility Directive” (EMC) must be adhered to.

1.2 Where wireless technologies are used

While driving

Radio frequencies can interfere with electronic systems in vehicles, such as car radios or security devices, etc.

Vehicles equipped with airbags

An enormous force is released when airbags are activated. Therefore, do not place the terminal in the area above the airbag or in the space in which the airbag could deploy. Terminals that are improperly installed can cause serious injury upon deployment of an airbag.

Electronic devices

Most modern electronic devices, such as those used in hospitals and vehicles, are protected against radio frequencies. However, this is not the case with all electronic devices. Do not use your terminal in the proximity of medical equipment without obtaining prior permission.

Heart pacemaker/other medical devices

Terminals can affect the functioning of implanted heart pacemakers and other medically implanted devices. Patients with a heart pacemaker should be informed that the use of terminals in the immediate vicinity of a pacemaker can lead to malfunctions. Do not pass the terminal over the pacemaker. The risk of a malfunction however, is minor if a minimum distance of 15 cm between the terminal and the pacemaker is maintained. If you suspect that malfunctions are occurring, put the terminal aside. If necessary, consult your cardiologist. If other medical devices are used in or on the body, then the equipment manufacturer should be consulted as to whether such devices are sufficiently protected against radio frequency signals. Do not use the terminal where the devices are implanted.

Hearing aids

Under certain circumstances, terminals can cause some hearing aids to malfunction. Contact the dealer/manufacturer of your hearing aid.

Other medical equipment

If you use a medical device, please contact the manufacturer to determine whether it is sufficiently protected against electromagnetic waves. If necessary, your attending physician could be helpful in obtaining this information. Equipment is often used in hospitals, medical offices and other facilities which is highly sensitive to external electromagnetic waves. Do not use the terminal in such locations.

Aeroplanes

To avoid interfering with the communication systems, do not use the terminal during the flight. Only activate the terminal on the ground with permission from the ground personnel.

Potentially explosive areas

Do not use the terminal in explosive zones or areas bearing signs with “Switch off sending/receiving devices”. Do not use the terminal in such potentially explosive locations.

Appropriately marked locations

Follow instructions and do not use the terminal in locations with obvious signs and instructions prohibiting such use.

1.3 CE declaration of conformity

The CE declaration of conformity is found on the SIX Payment Services homepage at:
www.six-payment-services.com

Every effort has been made to ensure that the information in this document is complete and exact at the date of printing. Further developments in the field of electronic payment traffic and technological progress could result in changes that might deviate from the description in this user guide.

Consequently, SIX Payment Services Ltd accepts no responsibility for the information provided in the operating instructions being current, complete or correct. Furthermore, to the extent permitted under the relevant legal provisions, SIX Payment Services Ltd accepts no responsibility in connection with the operating instructions.

The menu navigation on the terminal has been designed to be self-explanatory, making this document necessary only in case of emergency.

The latest version of the user guide, together with any updates, can be found on our homepage at:
www.six-payment-services.com

2 Product info

2.1 Terminal overview



2.2 Display symbols

WLAN Only appears if a WLAN card (optional) is installed and WLAN communication is also in use.



WLAN is connected to an access point, the IP address is valid, and the reception strength is 100%.



WLAN is connected to an access point, the IP address is valid, and the reception strength is greater than 66%.



WLAN is connected to an access point, the IP address is valid, and the reception strength is greater than 33%.



WLAN is connected to an access point, the IP address is valid, but reception is poor.

! If the WLAN symbol flashes, there is a connection to the access point, but the IP address is invalid.

! If the WLAN symbol does not appear, either WLAN is not available or there is no connection to the access point.

PSTN



PSTN communication is active and online (the connection is live).

! If the PSTN symbol flashes, the PSTN connection is active but communication between the host and the terminal is interrupted (DCD not active).

! If the PSTN symbol does not appear, PSTN is either not in use or not available.

ISDN

Only appears if an ISDN card (optional) is installed and ISDN communication is also in use.



ISDN communication is online (PPP is active).

! If the ISDN symbol flashes, the terminal is attempting to set up an ISDN connection.

! If the ISDN symbol does not appear, ISDN is either not in use or not available.

Ethernet



The Ethernet cable is plugged in and the terminal has a valid IP address.

! If the Ethernet symbol flashes, the Ethernet cable is plugged in, but the terminal does not have a valid IP address.

! If the Ethernet symbol does not appear, either the cable is not plugged in or Ethernet is not available.

**GSM/GPRS
Reception
strength**

Only appears if a GPRS card (optional) is installed and GPRS communication is also in use.



There is a connection to the network and the reception strength is 100%.



There is a connection to the network and the reception strength is greater than 80%.



There is a connection to the network and the reception strength is greater than 60%.



There is a connection to the network and the reception strength is greater than 40%.



There is a connection to the network and the reception strength is greater than 20%.

! If the GSM/GPRS symbol does not appear, GSM/GPRS is not assigned to a network or reception is too poor to set up a connection.

The reception strength is supplemented by one of the two symbols shown below.



GSM is in use, GPRS is not available/in use.

! If the GSM/GPRS symbol flashes, it is in use but offline.



GSM/GPRS is in use (GPRS mode).

! If no supplementary symbol appears, GSM/GPRS is not available.

**GSM/GPRS
Data transmission**



This symbol always appears together with a communication symbol. It shows that a transaction is running.



This symbol appears with either the Ethernet or the WLAN symbol. It shows that a secure connection is active.

2.3 Abbreviations/Information

Cards with a chip	Cards which store the information needed for electronic payment on a chip must be inserted in the chip reader.
Cards with a magnetic strip	Cards which store the information needed for electronic payment on a magnetic strip must be pulled through the swipe reader.
CC	Computer centre
CCC	Credit card company
CrC	Credit cards
CVC/CVV	Card Verification Code/Card Verification Value number used to identify the card.
ECR	Electronic Cash Register
EFT/POS	Electronic fund transfer at the point of sale.
EMV	Global specifications from Eurocard, MasterCard and VISA based on a chip card.
ep2	<EFT/POS 2000>, Swiss standard based on the EMV standard in electronic payment traffic.
GPRS	General Packet Radio Service (GPRS) is a packet-oriented transmission service that is used in the field of mobile telephone systems.
GSM	Global Standard for Mobile Communications
ISDN	ISDN – Integrated Service Digital Network
Online transaction	An online transaction is always directly authorised at the CCC.
Offline transaction	An offline transaction is authorised in interdependence with the card and terminal risk management (e.g. if the amount of the previous transactions is less than the card limit or if the amount is less than the terminal floor limit on the card, etc.).
PF	PostFinance (Switzerland)
PIN	Personal Identification Number
PIN-based transaction	For a PIN-based transaction, the customer must enter his/her PIN at the point of sale during the payment process.
PSTN	Analogue telephony
PSW	Password
PUK	Personal Unblocking Key
Tip	Tip
TRM	Terminal
TRX	Transaction
WLAN	A Wireless Local Area Network is a “wireless” local radio network, which generally refers to a standard within the IEEE 802.11 family.

2.4 Payment procedure with ep2

The payment process at the point of sale is standardised for all cards with ep2. A variety of card types are in circulation today. Many card issuers intend to provide their customers with EMV chip cards in the coming years.

- Cards for which the card information is only present on the magnetic strip must be pulled through the swipe reader.
- Cards with a chip must be inserted in the chip card reader.
- If a chip card is pulled through a swipe reader, the customer is prompted to insert it in the chip reader.
- If a card with a magnetic strip is inserted in a chip reader, the message “Card unknown” is displayed. The customer **must** pull the card through the swipe reader.

Payment functions

ep2 offers a full range of transaction modes and functions. The transactions activated on your terminal are determined by the settings in the service centre as global parameters and by the individual card processors.

e.g. Tip:

This transaction type is often used in the hotel and restaurant industry. In the retail business, however, it is unnecessary.

- Depending on the payment function and credit card processor, different minimum/maximum amounts, day limits, etc. can be defined.
- Functions are described in general in this document. Please note that some transaction modes and functions may be inactive on your device.

Caution for offline transactions!

Offline transactions are stored in the security section of your terminal and submitted to the card processor by means of the daily closing. This can be carried out manually by the terminal operator or automatically.

Should the security section of the device be defective, intentionally damaged or stolen, the stored transactions will be lost.

For this reason, we recommend that you:

- Meticulously retain all sales slips.
- Carry out a daily closing every day or more often.
- Always carry out a daily closing before making installation changes, etc.
- Always carry out a daily closing for anticipated longer absences from the business.
- A closing must be carried out for seasonal operations, at the end of the season.

2.5 Technical information

Operating temperature

0°C to 50°C

Humidity (not condensing)

20% to 85%

Power supply

100–240 VAC 50/60 Hz/0,7 A

3 Commissioning

3.1 Installation

- Position the device at its intended location
- Connect the device.
Always plug in the power supply last!
- Cable:
 - ! Only the original cables delivered with the product should be used.
- Communications cable: black.
- Network cable: double pole, black/white marking.
- ECR cable: black, cable with DB9 female and RJ45 plug.

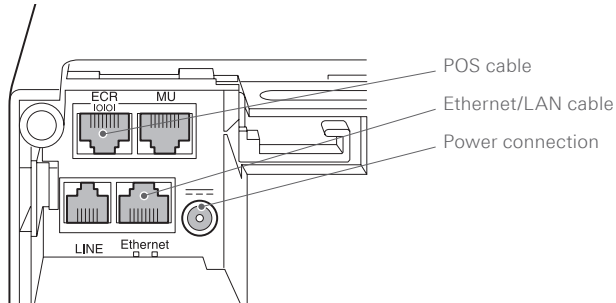

The terminal starts up and reports with an acoustic signal when it is ready to operate. The terminal can then be initialized in accordance with the separate configuration sheet.

3.2 Configuration/Initialization

First initialisation







The terminal is provided to you in a non-configured state and must be configured to be operable. Please read the configuration sheet delivered with the device. It contains all specific data for your terminal. The terminal configuration procedure is described in detail in the configuration sheet. Initialization requires several minutes. Wait until the terminal displays the welcome message.

Subsequent initialization

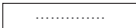
Should it be necessary to re-initialize a device for any reason, proceed as outlined on page 18.

Key

The following symbols are used in the descriptions in this document.

	Function selection by choosing the corresponding number or using the cursor and the <OK> button.
	Insert card. Depending on the card type, it must be inserted in the chip card reader, held up to the contactless reader or pulled through the magnetic swipe reader.
	Remove card.
	Sales slip printout.
	Request the customer's signature.
	Processing and/or communication.
	Manual entry of the card data. Press function button.

4. Transactions

4.1 Card without PIN

Transaction

A transaction is prepared by the merchant before being confirmed by the customer. The voucher is then printed by the cash till printer.

Preparation





Transactions are prepared on the cash till and then transferred to the terminal. You will find information on preparation in the operating instructions you received with your cash till.

Once the transaction has been prepared by the merchant, the customer is prompted by the terminal to insert his card.

Depending on the card type, the two following procedures are possible:





- Customer handling: card without PIN.
- Customer handling: card with PIN (see p.14).

Customer handling – card without PIN

1.	Depending on the card type, it must be inserted in the chip card reader, held up to the contactless reader or pulled through the magnetic swipe reader. If the customer uses the wrong reader for his or her card, that person is instructed to use the proper reader.	
2.	Enter the amount. Confirm with <OK>.	
3.	Payment will be recorded and systematically authorised online. Chip cards: the card must remain inserted in the chip reader throughout the transaction, until the request to remove it appears.	
4.	A sales slip is printed out. The sales slip must be signed by the customer.	

4.2 Card with PIN

Customer handling – card with PIN

1.	Depending on the card type, it must be inserted in the chip card reader, held up to the contactless reader or pulled through the magnetic swipe reader. If the customer uses the wrong reader for his or her card, that person is instructed to use the proper reader.	
2.	The amount is displayed in the foreign currency and the customer is prompted to enter the PIN-code (4 to 6 digits) and to confirm with <OK>. If the amount is incorrect, the transaction can be aborted using <STOP> → if no purchase is made. Timeout: the process will be aborted if processing does not occur within 30 seconds.	<PIN> 
3.	Payment is recorded and systematically authorised online.	
4.	For chip cards, the customer will be prompted to remove the card. Chip cards: the card must remain inserted in the chip reader throughout the transaction until the request to remove it appears.	
5.	A sales slip is printed out.	

Sample sales slip: certain fields may differ according to the purchase type.

COMPANY EXAMPLE EXAMPLE STREET 88 1234 EXAMPLE	•	Your company data that will be printed out on the sales slip.
DD.MM.YYYY HH.MM.SS	•	Transaction date and time.
Purchase Processing company		
XXXX 123456 1234 2	•	Customer card information: certain digits are shown with an X for data protection (depends on the CCC).
Expiry date: MM.YY	•	Customer card expiry date.
Trm-Id: 12345678		
Akt-Id: 00000001		
AID: A99999999999	•	Transaction information for unambiguous identification of the transaction.
Trx. Ref-No: 999999999999		
Trx. Seq-Nr.: 12345		
Aut. Code: 123456		
EPF: ABC123ABC123ABC		
Total-EFT USD: 123.45	•	Amount

5 Menu tree (illustration)

5.1 Main menu

You reach this menu tree by pressing the <Menu> button with the POS system drawer closed.

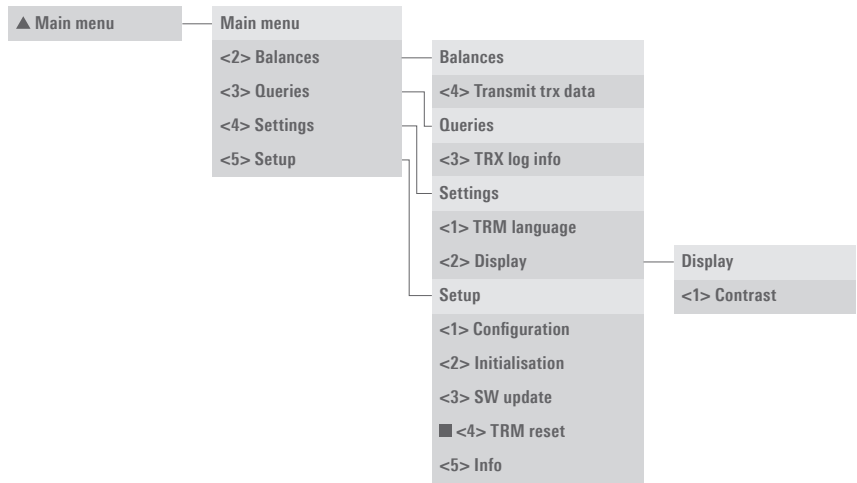

To enter the menu tree below, press the <STOP> button.

▲ Access only with your password. You can find this on the configuration sheet delivered with your terminal. ■ Access only for service technicians.

6 Balances

6.1 Start user shift/end user shift, daily closing, data transmission

<STOP> <2>

Balances

You can enter the terminal's main menu using the <STOP> button. Select the "Balances" function <2>. You then have the following options:

<STOP> <2> <4>

Transmit trx data (!)

With the "Transmit trx data" function, all transactions that have been conducted and stored in the terminal are transmitted. This function should always be used if a large number of transactions has been made.

→ **No further cancellations can be made after a "Transmit trx data".**

→ **No further tips can be recorded after a "Transmit trx data".**

! = Caution: If you initiate this function on the terminal, this is not registered by the cash till and may consequently result in your cash till not acting as expected. If you have any questions, please contact your cash till supplier.

7 Queries, settings

<STOP> <3>

Queries

You can enter the terminal's main menu using the <STOP> button. Select the "Queries" function <3>. You then have the following options:

<STOP> <3> <3>

TRX log info

The current status of transactions since the last data transmission is listed.

<STOP> <4>

Settings

You can enter the terminal's main menu using the <STOP> button. Select the "Settings" function <4>. You then have the following options:

<STOP> <4> <1>

TRM language

The terminal language can be adjusted.

This language setting is only applicable until the next service call. During the service call, the service host's language setting will be reactivated. If you prefer a permanent adjustment of the language setting, then this can be set by calling our hotline.

The customer language corresponds to the card's language code.

<STOP> <4> <2>

Display

You can set the contrast of the display screen with this function.

Once you have selected the contrast function, the contrast can be set using the function buttons directly below the display screen. As soon as the contrast is set, it **must** be confirmed with <OK>.

8 Setup

<STOP> <5> Setup → Password is requested

You can enter the terminal's main menu using the <STOP> button. Select the "Setup" function <5>. The following terminal-specific functions can be carried out. The following functions require a **password**.

<STOP> <5> <1> Configuration

The terminal calls the service centre and obtains the latest configuration parameters in the event that they have changed.

<STOP> <5> <2> Initialisation

You can re-initialise individual or all card providers.

<STOP> <5> <3> SW update

The terminal calls the service host and downloads the latest software version, if one exists. The software download may require several minutes. Please be patient and do not unplug the terminal.

<STOP> <5> <4> Trm reset

This function is only available to the service technicians and is password-protected.

<STOP> <5> <5> Info

The terminal ID and the current software version are displayed.

9 Maintenance and handling

9.1 Care and maintenance

- Keep the product, its parts and accessories out of the reach of small children.
- Handle the device carefully and keep it in a clean, dust-free location.
- Do not place the device in a location with extremely low or high temperatures. Do not place the device in the proximity of burning candles, cigarettes, cigars, open fires, direct sunlight, etc.
- Do not drop, throw or bend the device. Careless handling can cause product damage or loss of the saved transactions.
- Do not paint the device.
- Do not attempt to open the device. Improper handling can cause damage or loss of the saved transactions. Only persons authorised by SIX Payment Services Ltd can carry out maintenance work.
- Do not use any accessories with this product that are not SIX Payment Services Ltd original accessories.
The guarantee does not apply to errors caused by use of non-original accessories.
- Do not use any corrosive chemicals, cleansers or cleaning agents to clean the device. Clean the device using a soft, lint-free moist cloth with mild soap. The display protector is made of plastic.
- **Cleaning the card reader:** To ensure perfect operation, it is important to clean the card reader regularly using a cleaning card. You are recommended to clean the terminal whenever read problems occur, but at least once a month. To do so, you should use damp cleaning cards which you pull through the card reader five to ten times on each side. You can order cleaning cards from our online store at www.six-payment-services.com/shop.

9.2 Identifying and solving errors

Host timeout

The corresponding computer centre does not reply. Possible reason: network overload.

Reading error, card cannot be read

Clean the reading unit.

Card information can also be entered manually.

No display

Check that all the leads are properly connected.

Important: Always connect the power supply last.

Terminated, no line

Check that the terminal is properly connected.

Check that the telephone line is active.

Status display and tool

1. Display messages must be confirmed using the <OK> button.	All display messages on the terminal must be confirmed with <OK>.
2. Display message: Use swipe reader.	A magnetic strip-based card has been inserted in the chip reader.
3. Display message: Please use whip reader.	A chip-based card has been pulled through the swipe reader.

Your personal contact: www.six-payment-services.com/contact

SIX Payment Services Ltd
Hardturmstrasse 201
8005 Zurich
Switzerland

SIX Payment Services (Europe) S.A.
10, rue Gabriel Lippmann
5365 Munsbach
Luxembourg